



Instruction Manual  
**eddyNCDT 3010**

DT3010-U05-A-C2  
DT3010-U05-M-C2  
DT3010-U1-A-C3  
DT3010-U1-M-C3  
DT3010-S1-A-C3  
DT3010-S1-M-C3

DT3010-S2-A-C3  
DT3010-S2-M-C3  
DT3010-U3-A-C3  
DT3010-U3-M-C3  
DT3010-U6-A-C3  
DT3010-U6-M-C3

DT3010-U15-A-C3  
DT3010-U15-M-C3

Non Contact Compact Displacement Measuring System on Eddy Current Principle

MICRO-EPSILON  
MESSTECHNIK  
GmbH & Co. KG  
Königbacher Strasse 15

94496 Ortenburg / Germany

Tel. +49 (0) 8542 / 168-0  
Fax +49 (0) 8542 / 168-90  
e-mail [info@micro-epsilon.de](mailto:info@micro-epsilon.de)  
[www.micro-epsilon.com](http://www.micro-epsilon.com)

Certified according to DIN EN ISO 9001: 2008

---

# Contents

<b>1.</b>	<b>Safety .....</b>	<b>5</b>
1.1	Symbols Used .....	5
1.2	Warnings .....	5
1.3	Notes on CE Identification .....	6
1.4	Proper Use .....	6
1.5	Proper Environment .....	7
<b>2.</b>	<b>System Description .....</b>	<b>7</b>
2.1	Area of Application .....	7
2.2	Measuring Principle .....	7
2.3	Structure of the Complete Measuring System .....	8
2.4	Technical Data .....	9
<b>3.</b>	<b>Delivery .....</b>	<b>11</b>
3.1	Unpacking .....	11
3.2	Storage .....	11
<b>4.</b>	<b>Commissioning .....</b>	<b>12</b>
4.1	System Components .....	12
4.1.1	Sensor .....	12
4.1.2	Sensor Cable .....	13
4.1.3	Controller .....	14
4.2	Synchronization in Multichannel Systems .....	15
4.3	System Adjustment .....	16
4.4	Sensor Mounting .....	16
4.4.1	Standard Mounting .....	16
4.4.2	Flush Assembly .....	18
4.5	Laying Sensor Cables .....	19
<b>5.</b>	<b>Operation .....</b>	<b>20</b>
5.1	Checking the Measuring System Setup .....	20
5.2	Connect the Measuring System .....	20
5.3	Control Elements .....	22
5.4	Calibration and Linearization .....	23
5.4.1	Controller DT3010 .....	23
5.4.2	Shifting the Output Characteristic .....	27

---

<b>6.</b>	<b>Elimination Errors</b> .....	<b>28</b>
<b>7.</b>	<b>Warranty</b> .....	<b>29</b>
<b>8.</b>	<b>Service, Repair</b> .....	<b>29</b>
<b>9.</b>	<b>Decommissioning, Disposal</b> .....	<b>29</b>
<b>Appendix</b>		
<b>A 1</b>	<b>Accessories</b> .....	<b>30</b>
<b>A 2</b>	<b>Spare Parts</b> .....	<b>32</b>
<b>A 3</b>	<b>Dimensional Drawings</b> .....	<b>34</b>
A 3.1	Sensors .....	34
A 3.2	Sensor Cable .....	36
A 3.3	Controller .....	36

## 1. Safety

The handling of the system assumes knowledge of the instruction manual.

### 1.1 Symbols Used

The following symbols are used in this instruction manual.



Indicates a hazardous situation which, if not avoided, may result in minor or moderate injuries.



Indicates a situation which, if not avoided, may lead to property damage.



Indicates a user action.



Indicates a user tip.

Measure

Indicates a hardware or a button/menu in the software.

### 1.2 Warnings



Connect the power supply and the display / output device in accordance with the safety regulations for electrical equipment.

- > Danger of injury
- > Damage to or destruction of the sensor and / or controller

The power supply must not exceed the specified limits.

- > Danger of injury
- > Damage to or destruction of the sensor and / or controller



Avoid shock and vibration to the sensor and / or controller.

- > Damage to or destruction of the sensor and controller

Protect the sensor cable against damage

- > Failure of the measuring device

### **1.3 Notes on CE Identification**

The following applies to the eddyNCDT 3010:

- EU directive 2004/108/EC
- EU directive 2011/65/EC, “RoHS” category 9

Products which carry the CE mark satisfy the requirements of the EMC directives and the standards (EN) listed therein.

The EC declaration of conformity is kept available according to EC regulation, article 10 by the authorities responsible at

MICRO-EPSILON MESSTECHNIK GmbH & Co. KG  
Königbacher Str. 15  
94496 Ortenburg / Germany

The system is designed for use in industry (in industrial and residential areas) and satisfies the requirements.

### **1.4 Proper Use**

- The eddyNCDT 3010 series is designed for use in industrial areas.
- It is used for machine supervision and for measuring and testing in process quality control.
- The system may only be operated within the limits specified in the Technical Data, see Chap. 2.4.

- ➡ Use the system in such a way that in case of malfunctions or failure personnel or machinery are not endangered.
- ➡ Take additional precautions for safety and damage prevention for safety-related applications.

## 1.5 Proper Environment

- Protection class:
  - Sensor: IP 65
  - Controller: IP 54
- Operating temperature:
  - Sensor, sensor cable: -50 ... +150 °C (+122 ... +302 °F)
  - Controller: +10 ... +50 °C (+50 ... +122 °F)
- Storage temperature:
  - Sensor, sensor cable: -50 ... +150 °C (+122 ... +302 °F)
  - Controller: -25 ... +75 °C (-13 ... +167 °F)
- Humidity: 5 - 95 % (non-condensing)
- Ambient pressure: Atmospheric pressure
- Power supply: 24 VDC / 205 mA

## 2. System Description

### 2.1 Area of Application

The eddyNCDT 3010 non-contact, compact displacement measuring systems are designed for industrial applications in production plants, for machine supervision and for measuring and testing in in-process quality assurance.

### 2.2 Measuring Principle

The eddyNCDT 3010 (Non-Contacting Displacement Transducers) displacement measuring system operates without contact using eddy current technology. It is used for making measurements on targets made of either ferromagnetic or non-ferromagnetic electrically conductive materials.

High-frequency alternating current flows through a coil cast in a sensor casing. The electromagnetic coil field induces eddy currents in the conductive target thus changing the ac resistance of the coil. This change in impedance is interpreted by demodulation electronics which generate an electrical signal proportional to the distance of the target from the sensor.

A patented electronic compensation technique reduces temperature-dependent measuring errors to a minimum.

### 2.3 Structure of the Complete Measuring System

The eddyNCDT3010 non-contact single channel displacement measuring system, see Chap. 2.1, consists of:

- Sensor
- Sensor cable
- Connection cable
- Controller, built into a compact aluminum housing

**i** The components are matched. The allocation of the sensor and the controller is determined by the serial number.



Fig. 1 eddyNCDT 3010 with controller and sensors



## 2.4 Technical Data

Model	DT3010-U05-A-C2	DT3010-U05-M-C2	DT3010-U1-A-C3	DT3010-U1-M-C3	DT3010-S1-A-C3	DT3010-S1-M-C3	DT3010-S2-A-C3	DT3010-S2-M-C3	DT3010-U3-A-C3	DT3010-U3-M-C3	DT3010-U6-A-C3	DT3010-U6-M-C3	DT3010-U15-A-C3	DT3010-U15-M-C3
Non-ferromagnetic target	•		•		•		•		•		•		•	
Ferromagnetic target		•		•		•		•		•		•		•
Measuring range	mm	0.5	1	1	1	1	2	2	3	3	6	6	15	15
Start of measuring range	mm	0.05	0.1	0.1	0.1	0.1	0.2	0.2	0.3	0.3	0.6	0.6	1.5	1.5
Linearity		≤ ±0.25 % F.S.O.												
Static resolution <sup>1</sup>	μm	0.025	0.05	0.05	0.05	0.05	0.1	0.1	0.15	0.15	0.3	0.3	0.75	0.75
		0.005 % F.S.O.												
Frequency response		25 kHz (-3 dB)												
Operating temperature	Sensors, cable	-50 up to 150 °C (-60 to 300 °F)												
	Controller	10 up to 50 °C (50 to 125 °F)												
Storage temperature	Sensors, cable	-50 up to 150 °C (-60 to 300 °F)												
	Controller	-25 up to 75 °C (-15 to 170 °F)												
Temperature stability (≤ Midrange)	Sensors	≤ 0.025 % F.S.O / °C												
	Controller	≤ 0.05 % F.S.O / °C												
Temperature compensation		Standard: 10 up to 65 °C												
Repeatability	μm	0.05	0.1	0.1	0.1	0.1	0.2	0.2	0.3	0.3	0.6	0.6	1.5	1.5
Signal output		Standard: 0 ... 10 V / 10 mA and 4 ... 20 mA												
Power supply		24 VDC (9 ... 30 V) / 205 mA												
Synchronization		With cable SC 30, see Chap. A 1.												

<b>Model</b>		<b>DT3010-U05-A-C2</b>	<b>DT3010-U05-M-C2</b>	<b>DT3010-U1-A-C3</b>	<b>DT3010-U1-M-C3</b>	<b>DT3010-S1-A-C3</b>	<b>DT3010-S1-M-C3</b>	<b>DT3010-S2-A-C3</b>	<b>DT3010-S2-M-C3</b>	<b>DT3010-U3-A-C3</b>	<b>DT3010-U3-M-C3</b>	<b>DT3010-U6-A-C3</b>	<b>DT3010-U6-M-C3</b>	<b>DT3010-U15-A-C3</b>	<b>DT3010-U15-M-C3</b>
Protection class	Sensors	IP 65													
	Controller	IP 54													
Sensor weight <sup>2</sup>	g	0.6	1.5	5	9	7.5	22	24							

1) Based on midrange

2) without cable

F.S.O. = Full Scale Output

MMR = Midrange

Measuring systems of the eddyNCDT 3010 series measure targets made of electrically conductive materials.

A distinction is made between

- non-ferromagnetic materials and
- ferromagnetic materials

Adjustment	Target group	Reference material
A	Non-ferromagnetic	Aluminum
M	Ferromagnetic	Steel DIN 1.0037

Fig. 2 Sensor adjustment

Necessary target diameter:

For unshielded sensors: 3 times the sensor diameter

For shielded sensors: 1.5 times the sensor diameter

- i** It is possible to make measurements on small targets if:
- a linearity adjustment has been made in this arrangement and
  - the target is positioned exactly in the measuring axis.

### **3. Delivery**

#### **3.1 Unpacking**

- 1 Sensor
- 1 Sensor cable
- 1 Controller
- 1 Test log
- 1 Instruction manual
- 1 8-pol. DIN female connector (analog output/ power supply)

- ➡ Check the delivery for completeness and shipping damage immediately after unpacking.
- ➡ In case of damage or missing parts, please contact the manufacturer or supplier immediately.

You will find optional accessories in appendix, see Chap. [A 1](#).

#### **3.2 Storage**

- Storage temperature:
  - Sensor and sensor cable: -50 ... +150 °C (-58 to +302 °F)
  - Controller: -25 ... +75 °C (-13 to +167 °F)
- Humidity: 5 - 95 % (non condensing)

## 4. Commissioning

### 4.1 System Components

#### 4.1.1 Sensor

The eddyNCDT measuring system will be used with unshielded or shielded sensors.

#### **NOTICE**

In radial direction metal parts may act as a target.

Falsifying the measuring result.

#### **Unshielded sensors, see Fig. 3**

- Type designation: U..
- Structure: The sensor cap with embedded coil is made of non-conductive materials.



*Fig. 3 Unshielded sensor*

#### **Shielded sensors, see Fig. 4**

- Type designation: S..
- Structure: The sensor is encased up to the top by a steel casing with mounting thread. Radial parts in radial direction are screened.



*Fig. 4 Shielded sensor*

#### 4.1.2 Sensor Cable

The special coaxial sensor cable is available in two connection versions:

- Connection already integrated in the sensor, see [Fig. 5](#): Type U05, U1, S1, or
- plug-in connection cable, see [Fig. 6](#).

The standard cable (C3) has a length of 3 m.

Available as an option: 6 m cable (C6), see Chap. [A 2](#).

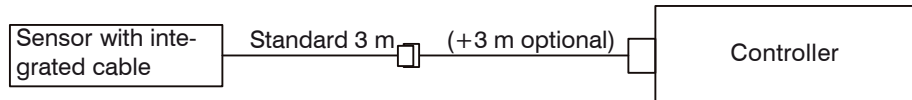

*Fig. 5 Type of sensor cable, connection integrated in the sensor*

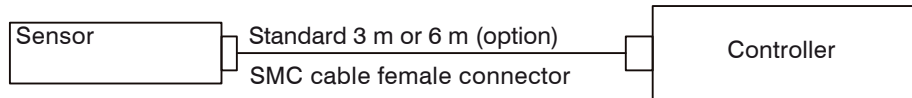

*Fig. 6 Type of sensor cable, plug-in connection cable*

➡ Connect the cable with the bulge at the controller.

The cables of one type are tuned to the same capacitance at the factory. This may result in deviations in length of +15 % in relation to the nominal length.

**i** Do not shorten the tuned cables, because this changes the capacity and the adjustment of the measuring system.

### 4.1.3 Controller

The controller DT3010, see [Fig. 7](#), is installed in an aluminum casing.

The oscillator and demodulator electronics are on one board.

- The oscillator electronics feed the sensor with a frequency and amplitude stable ac voltage.
- The demodulator electronics demodulates, linearizes and amplifies the distance dependent measuring signal.

The controller is already tuned to the delivered sensor with sensor cable at the factory.



*Fig. 7 Controller DT3010 with connecting elements*

**i** The power and output cable PC3/8 can be delivered as an accessory, see [Chap. A 1](#).

## 4.2 Synchronization in Multichannel Systems

Several measuring systems in the eddyNCDT 3010 series can be operated simultaneously as multichannel systems.

Synchronization of the measuring systems avoid interference between the sensors.

➡ Plug the SC30 synchronization cable, available as an accessory, see Chap. A 1, in the SYN OUT socket (synchronization output) in controller 1.

➡ Plug the other end on the cable into the SYN IN socket (synchronization input) in controller 2.

The oscillator in controller 2 switches automatically to synchronization mode, that is it acts as slave to the master oscillator in the controller 1. Nearby mounted sensors no longer interact therewith.

➡ Synchronize several measuring systems with the SC30 cable if necessary.

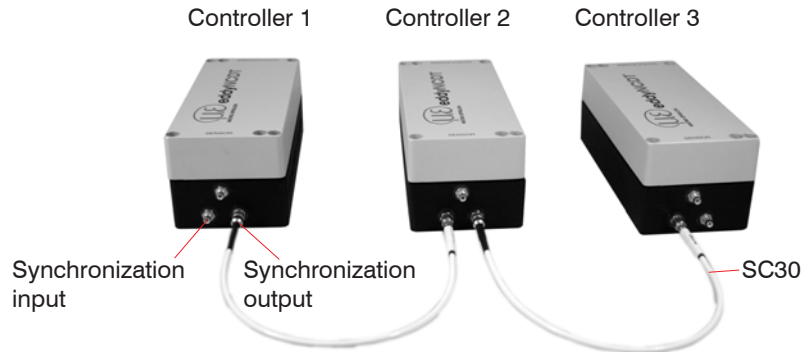

Fig. 8 Synchronized multichannel measuring system

### 4.3 System Adjustment

➡ Calibrate the measuring systems of the eddyNCDT series 3010 for his particular application before measuring, see Chap. 5.4.

Use, if possible

- the actual sensor mounting and
- the actual target

**i** If you cannot use the actual target, simulate the measuring environment as accurately as possible.

### 4.4 Sensor Mounting

Eddy current displacement sensors may be influenced by an adjacent metallic attachment.

Prefer the following sensor mountings according to the used sensor type

- unshielded sensors: Standard mounting
- shielded sensors: Flush mounting

#### 4.4.1 Standard Mounting

The sensors protrude beyond the metal support.

**Sensors with thread, see Fig. 9, see Fig. 10**

- ➡ Push the sensor through the hole in the sensor support.
- ➡ Screw the sensor tightening the mounting nuts on the thread protruding from the support on both sides.
- ➡ Tighten carefully to avoid damaging the sensors, especially the smaller ones.



**i** Prefer the standard mounting of the sensor, because you achieve optimum measuring results with this method!

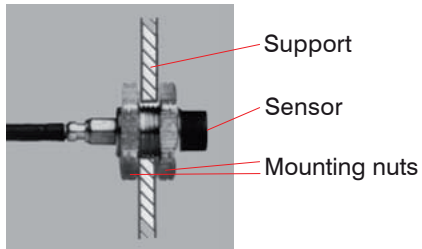

*Fig. 9 Unshielded sensor with thread in standard mounting*

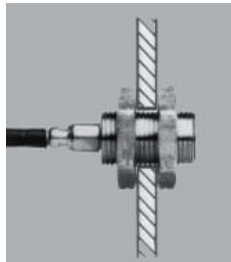

*Fig. 10 Shielded sensor with thread in standard mounting*

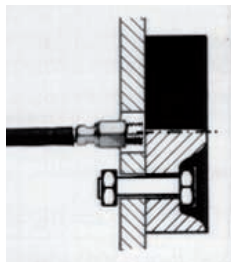

*Fig. 11 Sensor without thread in standard mounting*

**Optimum:**

Diameter of the sensor mounting plate = twice the diameter of the sensor

**i** When calibrating, keep the same relative position of the sensor to the support as in the measurement!

**Sensors without thread, see Fig. 11**

- Fix the sensor to the metal mounting plate with nuts and bolts.
- Tighten the locking nuts on the threaded pins carefully to avoid damaging the sensor, see Fig. 11.

**4.4.2 Flush Assembly**

**Sensors with thread**

- Mount the shielded or unshielded sensors flush in the sensor support made of an insulator material (plastic, ceramic and so on).
- Mount shielded sensors flush in the metal sensor support, see Fig. 12.
- Mount unshielded sensors flush in the metal sensor support, see Fig. 13.



Make a cut out in the support three times as big as the diameter of the sensor.

- Screw the sensors into the threaded hole in all types of mounting and lock the sensors with the mounting nut. Tighten carefully to avoid damage, especially to smaller sensors.



Calibrate the measuring system in the measuring setup with actual mounted sensor.

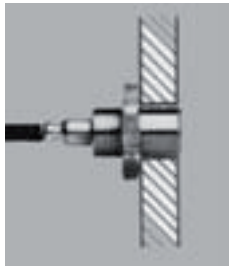

*Fig. 12 Example of flush assembly of a shielded sensor in a metal support*

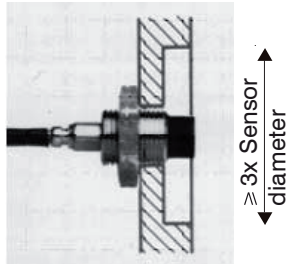

*Fig. 13 Example of flush assembly of an unshielded sensor in a metal support*

#### 4.5 Laying Sensor Cables

- Check that the SMC screw connections on the sensor and controller are tight.
- Lay the sensor cable in such a way that it is not damaged by sharp-edged or heavy objects.
- Do not kink the cable, the minimum bending radius is 30 mm.
- **i** Protect the cable against pressure in pressurized rooms.

**NOTICE**

- Do not damage the sensor cable.
- Protect the cable sheath.
  - Keep the minimum bending radius.
  - > Loss of functionality!

## 5. Operation

### 5.1 Checking the Measuring System Setup

- 1) Is the sensor adjusted for the application (target material)?
- 2) Are the sensor, sensor cable length and controller aligned (type and serial number)?
- 3) Is the sensor connected? Are the cable connections tight?

### 5.2 Connect the Measuring System

Setup the voltage supply to the controller.

Use the PC3/8 power supply and output cable available as an accessory, see Chap. A 1, or a user assembled cable.

- ➡ Connect the output cable to the 8-pole built-in socket, see Fig. 14, on the controller with the enclosed plug.
- ➡ Connect the output cable to a +24 VDC voltage supply (optional  $\pm 15$  VDC).
- ➡ Connect the measuring signal displays or recorders to the 8-pole built-in socket on the controller.
- ➡ Switch on the voltage supply.
- ➡ Let the measuring setup warm up for about 15 minutes.

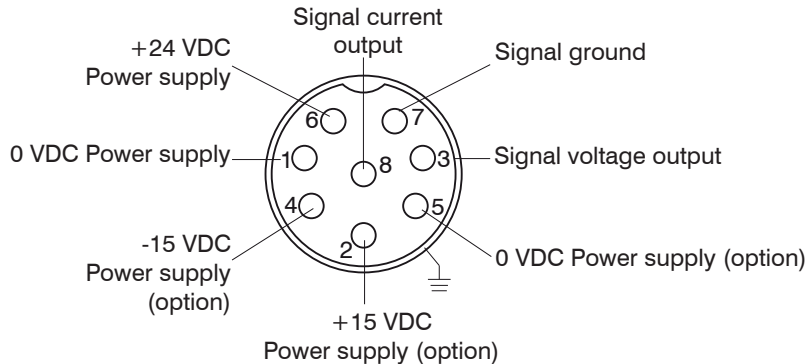

Fig. 14 Socket pin assignment and signal output for standard supply (+24 VDC) and optional supply ( $\pm 15$  VDC) - view on solder pin side female cable connector

**i** Requirements to power and output cable to satisfy the EMC regulations.

The power supply and signal output are connected by the 8-pin built-in connector (DIN 45326). Pin assignment, see Fig. 14, see Fig. 15. The controller contains an 8-pin cable socket for the user-side assembly of your own connecting cable. The EMC regulations are only satisfied under these basic conditions.

- Take the 8-pin cable socket which is enclosed at the controller.
- Use a double screened cable!
- Outer screening mesh surrounds all cable wires.
- Inner screening mesh surrounds signal wires PIN 3, 7, 8
- Inner screening mesh connected at Pin 7
- Total screen connected via connector housing to housing ground
- Recommended conductor cross-section 0.14 mm<sup>2</sup>

PC3/8 is a 3 m long, pre-assembled 8-wire power and output cable. It is supplied as an accessory, see Chap. A 1.

Pin	Cable color acc. to Din 47100	Assignment	
1	white	0 Volt	Standard power supply
6	green	+24 Volt	
2	brown	+15 Volt	Optional power supply
4	yellow	-15 Volt	
5	gray	0 Volt	
3	green	Signal voltage output	Inner cable 3-wire with screen
7	blue	0 Volt	
8	red	Signal current output	
	black	Outer screen	
	bare	Inner screen (connect with Pin 7, blue)	

Fig. 15 Pin assignment and color codes

### 5.3 Control Elements

➡ Remove the cover from the controller by loosening the four screws in the cover.

There are three trimmer potentiometers on the demodulator board, see [Fig. 16](#), for adjusting

- Zero,
- Gain and
- Linearity

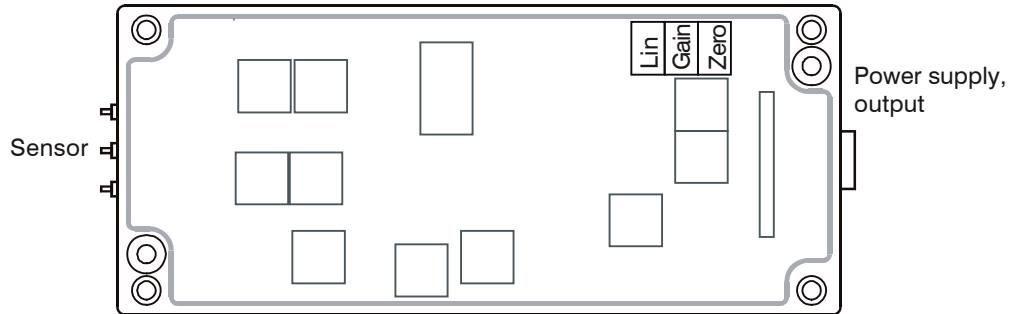

*Fig. 16 Potentiometers on the demodulator board*

The measuring signal can be adjusted in the range from 0 V to +10 V at a max. output current of 10 mA. The output is temporarily short-circuit-proof. The output impedance is less than 10 ohms. The controller consists a voltage and current output (4 ... 20 mA).

## 5.4 Calibration and Linearization

### 5.4.1 Controller DT3010

➡ Calibrate every measuring channel for the installation environment and the target prior to measuring. Set three trimmer potentiometers at three distance points.

These distance points (start of measuring range, midrange and end of measuring range) were specified by a reference norm for calibration.

#### Reference norm of calibration:

1) Special micrometer calibration device with non rotating micrometer spindle, available as an accessory, see [Fig. 17](#), or

2) spacing washers made of an insulator material (reduce the accuracy of calibration)

The trimmer potentiometers Zero, Gain and Linearity, see [Chap. 5.3](#), have 24 turns. You hear a slight click at the end positions of the trimmer potentiometers.

➡ Turn the trimmer potentiometer with a screwdriver in a clockwise direction to effect a positive change in the output voltage.

➡ Turn the trimmer potentiometer with a screwdriver in counterclockwise direction to effect a negative change in the output voltage.

**i** Use the original measuring environment for calibration where possible. Simulate the measuring environment if this is not possible.

➡ Connect and synchronize all channels in multichannel systems, see [Chap. 4.2](#).

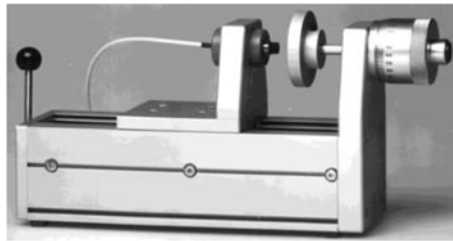

*Fig. 17 Micrometer calibration device*

**Step 1: Zero adjustment**

➡ Set the target at the start of measuring range to the sensor.

The start of measuring range is assigned to the sensor type.

Remove the values from the table below, see [Fig. 18](#).

Sensor model	Measuring range mm	Start of measuring range mm	Sensitivity <sup>1</sup> V/mm at 10 V output voltage
U05	0.5	0.05	20.00
U1	1	0.1	10.00
S1	1	0.1	10.00
S2	2	0.2	5.000
U3	3	0.3	3.333
U6	6	0.6	1.666
U15	15	1.5	0.666

*Fig. 18 Table zero adjustment*

Keeping the start of measuring range prevents measuring errors due to the sensor pressing against the target or mechanical damage to the sensor.

The start of measuring range corresponds to the measuring value 0.

➡ Set the output voltage to 0 V on the Zero potentiometer.

Example: output voltage = 10 V

**Step 2: Gain adjustment**

➡ Move the target to midrange.

The target is at a distance (start of measuring range and 1/2 measuring range) from the sensor.

➡ Set the output voltage on the Gain potentiometer to half the value of the desired voltage for full measuring range.

1) Output voltage for full measuring range



### Step 3: Linearity adjustment

➡ Move the target to the end of measuring range.

The target is at a distance (start of measuring range + measuring range) from the sensor.

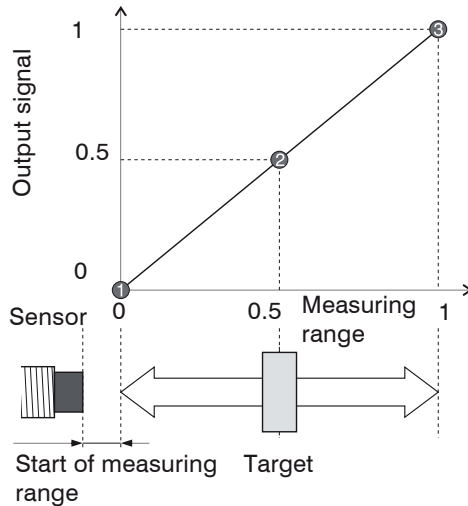

Fig. 19 Calibration steps

➡ Set the output voltage on the Linearity potentiometer to the value of the voltage desired for full range.

➡ Repeat zero, gain and linearity adjustment (steps 1 to 3) until the output voltage reaches the preset value at the three reference points.

**i** The highest sensitivity over the whole range is achieved at a calibration to 10 V output voltage. This gives the best signal/noise ratio.

**Example:** Calibration for voltage output:  
Sensor U12SW;  
Zero 0.0 V: Start of measuring range  
Gain 5.0 V: Midrange  
Linearity 10.0 V: End of measuring range

**Recommendation:**

To reduce the number of adjustment cycles, we recommend the following procedure:

- ➡ Zero adjustment: Set target at start of measuring range from the sensor.
- ➡ Set the output voltage to 0 V using the Zero potentiometer.
- ➡ Move the target to midrange.
- ➡ Set the output voltage from the Gain potentiometer to half the value (for example 5 volts) of the desired voltage for the full measuring range (for example 10 volts).
- ➡ Move the target to the full measuring distance (end of measuring range).

9.7 V appears, for example, on the display.

The setpoint is 10.00 V

- ➡ Set the output voltage using the Linearity potentiometer to the value 10.15 V.

The value 10.15 V is calculated as follows:

$10 \text{ V desired output voltage} + [(10 \text{ V desired output voltage} - 9.7 \text{ V displayed output voltage}) \times 0.5]$

- ➡ Repeat zero, gain and linearity adjustment until the output voltage reaches the preset value.
- ➡ Calibrate the system for the output current 4 - 20 mA as described at the beginning of Chapter.

**i** Zero and Gain adjustment have no effect on the total linearity of the system!

The zero can be shifted or the curve steepness changed after linearization.

- i** Check calibration after every sensor or sensor cable change.  
Re-linearize the measuring channel if necessary.

#### 5.4.2 Shifting the Output Characteristic



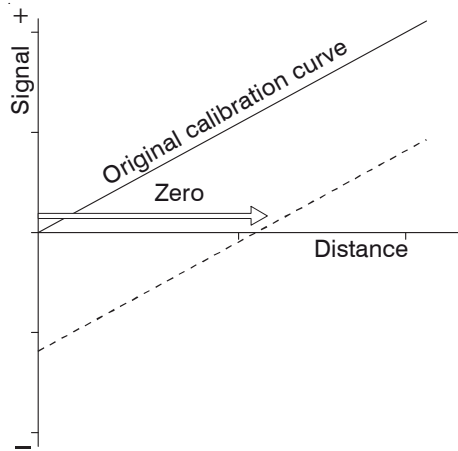

The electrical zero can be shifted later after linearizing the system output and installing the sensor:

- ➡ Shift the electrical zero by about 30 % of the measuring range, see [Fig. 20](#), re-adjust the Zero potentiometer for this.



*Fig. 20 Zero shift of calibration curve*

## 6. Elimination Errors

Error	Cause and solution
Output signal in negative saturation (< -12 V)	<ul style="list-style-type: none"> <li>- Cable and/or sensor not connected.</li> <li>- Sensor has open loop.</li> <li>- Cable is defective.</li> </ul> <p> Replace cable and/or sensor.</p>
Output signal oscillates at low frequency in multi-channel mode.	<ul style="list-style-type: none"> <li>- Interference between sensors</li> </ul> <p> Synchronize systems.</p>
No change in output signal	<p> Check supply voltage.</p> <p> Check allocation of sensor type and cable length.</p> <p> Check sensor and cable.</p>

## 7. Warranty

All components of the device have been checked and tested for perfect function in the factory. In the unlikely event that errors should occur despite our thorough quality control, this should be reported immediately to MICRO-EPSILON.

The warranty period lasts 12 months following the day of shipment. Defective parts, except wear parts, will be repaired or replaced free of charge within this period if you return the device free of cost to MICRO-EPSILON. This warranty does not apply to damage resulting from abuse of the equipment and devices, from forceful handling or installation of the devices or from repair or modifications performed by third parties.

No other claims, except as warranted, are accepted. The terms of the purchasing contract apply in full. MICRO-EPSILON will specifically not be responsible for eventual consequential damages. MICRO-EPSILON always strives to supply the customers with the finest and most advanced equipment. Development and refinement is therefore performed continuously and the right to design changes without prior notice is accordingly served. For translations in other languages, the data and statements in German language operation manual are to be taken as authoritative.

## 8. Service, Repair

In the event of a defect on the sensor, sensor cable or controller the parts concerned must be sent back for repair or replacement. In the case of faults the cause of which is not clearly identifiable, the whole measuring system must be sent back to:

MICRO-EPSILON MESSTECHNIK  
GmbH & Co. KG  
Königbacher Str. 15  
94496 Ortenburg / Germany

Tel. +49 (0) 8542 / 168-0  
Fax +49 (0) 8542 / 168-90  
info@micro-epsilon.de  
www.micro-epsilon.com



## 9. Decommissioning, Disposal

- ➡ Disconnect the sensor cable and the power supply and output cable on the sensor.
- ➡ Do the disposal according to the legal regulations (see directive 2002/96/EC).

## Appendix

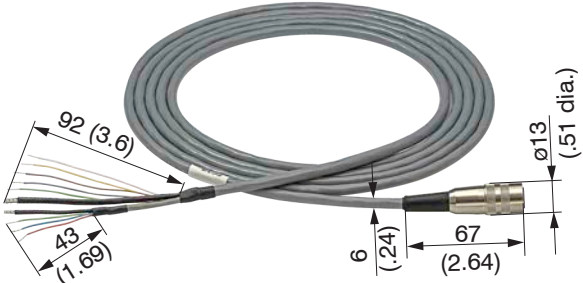
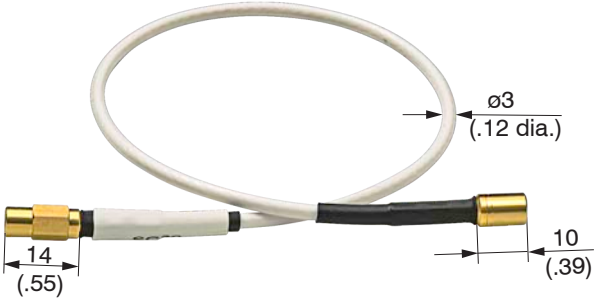
### A 1 Accessories

PS2020		<p>Power supply 24 VDC, for mounting on DIN rail, input 230 VAC, switchable for 110 VAC</p>
PC3/8		<p>Supply and output cable, 3 m / 10 ft long, 8-pin with a connector suitable for DT3010 electronics and cable lugs for connection to terminal block</p>
SC30		<p>Synchronization cable, length 30 cm, for connecting the electronics to be synchronized</p>

MC25D	 A silver metal calibration unit with a central slot and a digital display on the right side.	Micrometer calibration unit; setting range 0 - 25 mm, division 2 $\mu\text{m}$ , adjustable zero, for sensors U1 to U15
MC2.5	 A silver metal calibration unit with a central slot and a digital display on the right side.	Micrometer calibration unit; setting range 0 - 2.5 mm, division 0.1 $\mu\text{m}$ , for sensors U05, U1, S1 and S2
CSP2008	 A blue and white electronic controller with a small screen, buttons, and various ports.	Universal controller for two sensor signals

**A 2 Spare Parts**

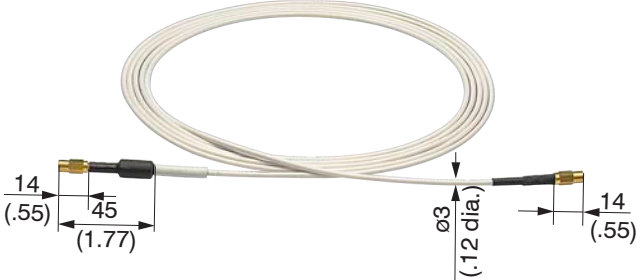
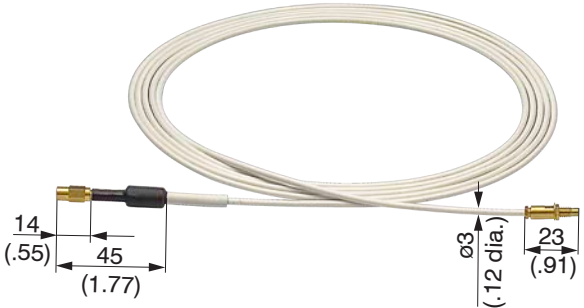
<p>C3</p>	 <p>Diagram of sensor cable C3. The cable is shown in a loop. Dimensions are provided for the connector and cable length: 14 (.55) for the connector length, 45 (1.77) for the cable length to the connector, and ø3 (.12 dia.) for the cable diameter.</p>	<p>Sensor cable, length 3 m (<math>\pm 15\%</math>) with straight SMC cable sockets</p>
<p>CE3</p>	 <p>Diagram of sensor extension cable CE3. The cable is shown in a loop. Dimensions are provided for the connector and cable length: 14 (.55) for the connector length, 45 (1.77) for the cable length to the connector, ø3 (.12 dia.) for the cable diameter, and 23 (.91) for the connector length.</p>	<p>Sensor extension cable, length 3 m (<math>\pm 15\%</math>) with straight SMC cable sockets and connector coupling to give a total length of 6 m</p>



<p>C6</p>	<p>Technical drawing of a sensor cable. The cable is coiled and has two SMC cable sockets. Dimensions are provided in millimeters and inches:</p> <ul style="list-style-type: none"> <li>Length from socket to start of coil: 14 (.55)</li> <li>Diameter of coil: <math>\varnothing 3</math> (.12 dia.)</li> <li>Length from socket to end of coil: 44 (1.73)</li> <li>Length of final segment: 14 (.55)</li> </ul>	<p>Sensor cable, length 6 m (<math>\pm 15\%</math>) with straight SMC cable sockets</p>
-----------	---	---

### A 3 Dimensional Drawings

#### A 3.1 Sensors

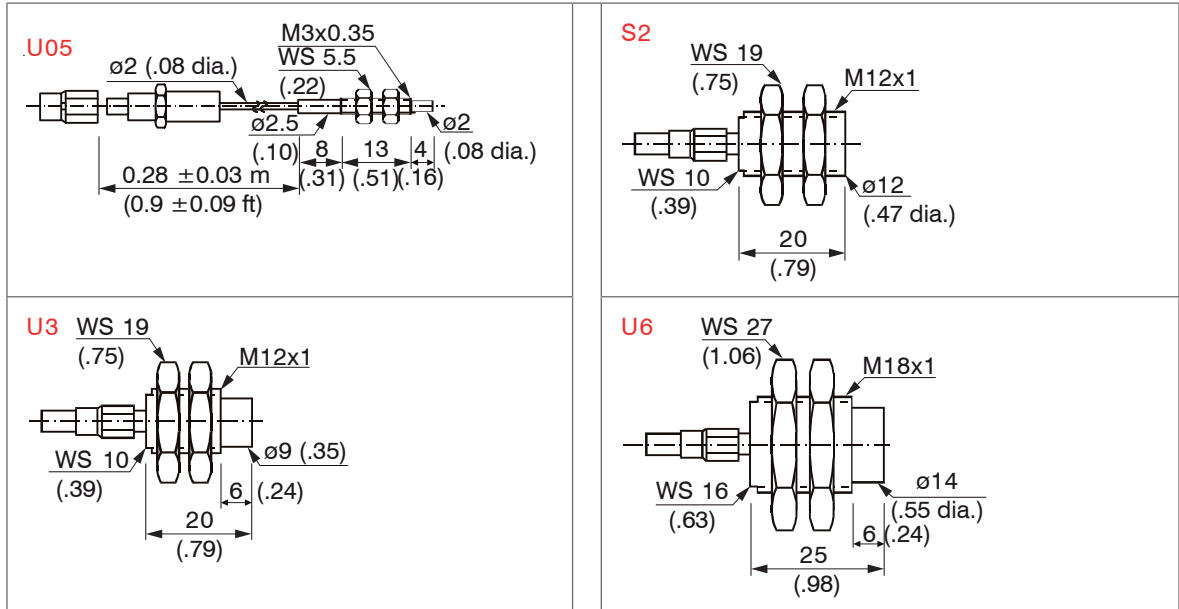

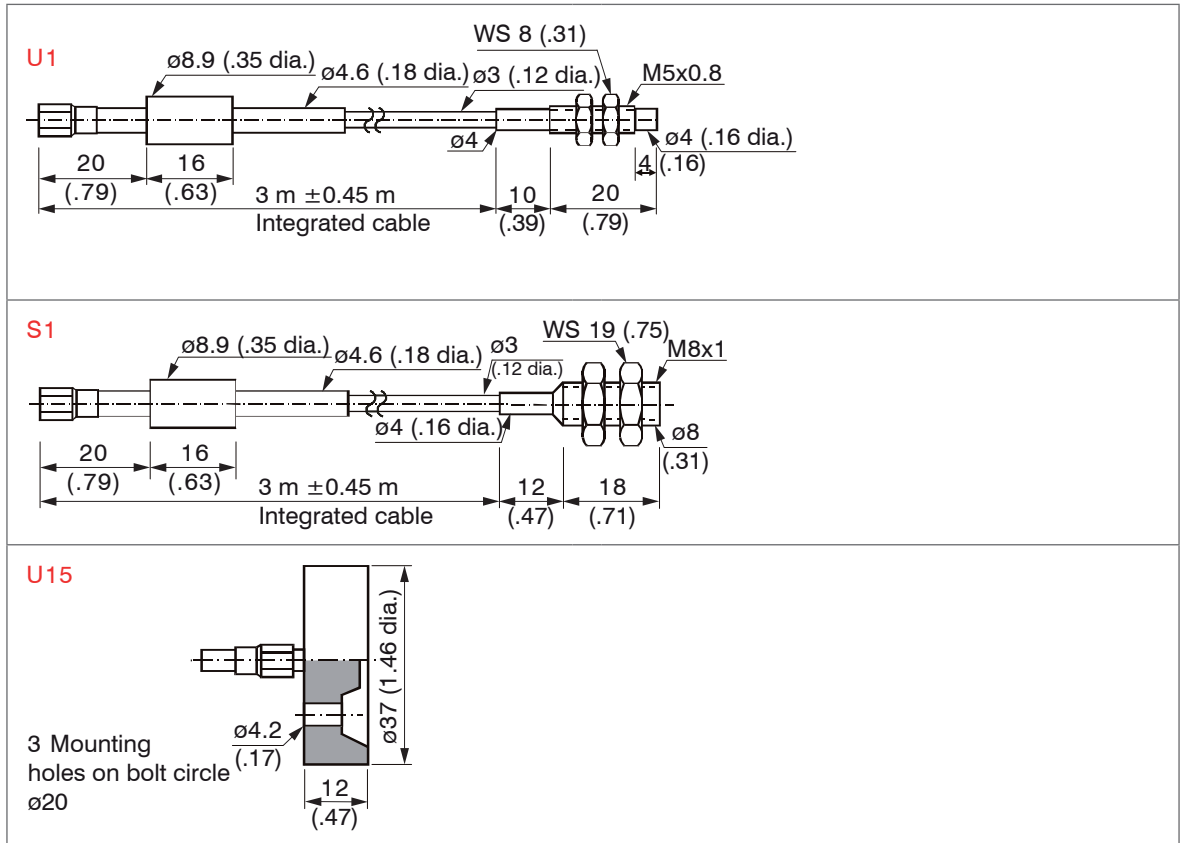

Dimensions in mm  
(inches), not to scale  
WS = Wrench size

### A 3.2 Sensor Cable

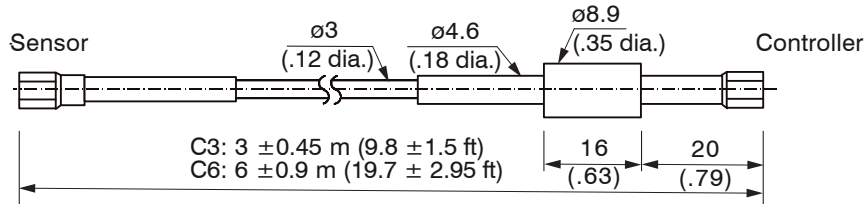

### A 3.3 Controller

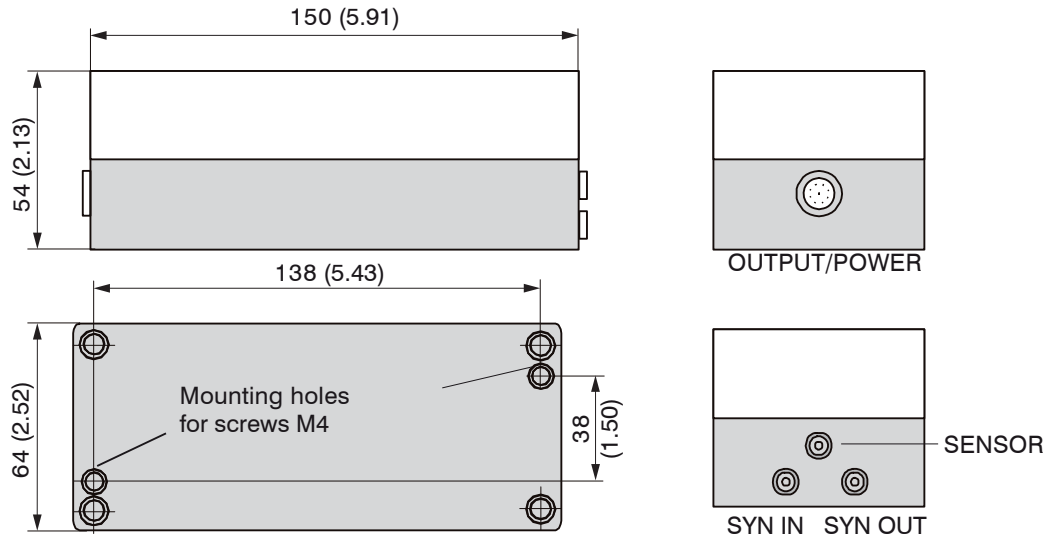

Dimensions in mm (inches), not to scale





MICRO-EPSILON MESSTECHNIK GmbH & Co. KG  
Königbacher Str. 15 · 94496 Ortenburg / Germany  
Tel. +49 (0) 8542 / 168-0 · Fax +49 (0) 8542 / 168-90  
info@micro-epsilon.de · www.micro-epsilon.com

X9751145-B021115HDR  
© MICRO-EPSILON MESSTECHNIK

