



# More Precision

**thermoMETER**  
Non-contact IR temperature sensors





### thermoMETER CTlaserM3

*Innovative precision infrared temperature sensor marking the actual spot size on your measurement target at any distance with 2.3µm wavelength for metal, ceramic and shiny targets*

- Measuring range from 50°C to 1800°C
- Special short wavelength (2.3µm) minimises errors caused by low emissivity for accurate temperature measurements on metal, shiny and ceramic targets down to 50°C
- Cooling and protection accessories for harsh environmental conditions
- Real mapping of the actual spot size, with automatic laser protection
- Precision optics (300:1 / 100:1 / 60:1) with different models for a specific focus point
- Extreme small measurement spot down to 0.45mm
- Only 1ms response time to capture fast events

### Optical specifications thermoMETER CTlaserM3

□ = smallest spot size (mm)

Standard Focus optics															
<b>3LSF</b>	<b>60:1</b>	20	20	20	20	20	19	19	19	18.3	19	25	30	40	53
<b>3HSF</b>	<b>100:1</b>	20	19	18	17	16	15	14	12	11	13	16	20	28	38
<b>3 H1/H2/H3 SF300</b>	<b>300:1</b>	20	17.8	15.5	13.2	11	8.6	6.4	4.8	3.7	5.5	8.6	11.8	17	26.6
<i>distance (mm)</i>		0	150	300	450	600	750	900	1000	1100	1200	1350	1500	1750	2200
Close Focus optics															
<b>3LCF1</b>	<b>60:1</b>	20	11.3	1.4	10.3	17.8	30.4	43	56	81	106	132	157	182	
<b>3HCF1</b>	<b>100:1</b>	20	11	0.85	9.5	16.8	29.1	41.4	53.6	78.2	103	128	152	177	
<i>distance (mm)</i>		0	40	85	120	150	200	250	300	400	500	600	700	800	
Close Focus optics															
<b>3LCF2</b>	<b>60:1</b>	20	14.2	8.4	2.5	10	17.5	25	40	55	70	85	100		
<b>3HCF2</b>	<b>100:1</b>	20	14	7.7	1.5	8.7	16	23	38	52	66	81	95		
<b>3 H1/H2/H3 CF2</b>	<b>300:1</b>	20	13.5	7	0.45	7.3	14	21	34.5	48.2	61.8	75.4	89		
<b>3LCF3</b>	<b>60:1</b>	20	16	11.7	7.6	3.4	9.3	15.1	27	39	51	62	74		
<b>3HCF3</b>	<b>100:1</b>	20	15.5	11	6.5	2	7.5	13	24	35	46	57	68		
<b>3 H1/H2/H3 CF3</b>	<b>300:1</b>	20	15.2	10.3	5.5	0.7	5.8	11	21.2	31.5	41.8	52.1	62.4		
<i>distance (mm)</i>		0	50	100	150	200	250	300	400	500	600	700	800		

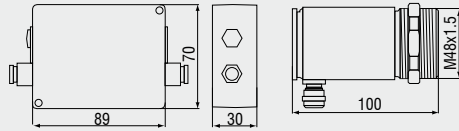

### Product identification

**CTLM - 3 L SF60 - C3**

Cable length [3m Standard / 8m / 15m]  
 Focus [SF60/100 / CF1 / CF2 / CF3 / CF4]  
 Temperature range [L / H]  
 Spectral range [2.3μm]  
 thermoMETER CTLaserM3

Model	CTLM-3LSF60-C3	CTLM-3HSF100-C3	CTLM-3H1SF300-C3	CTLM-3H2SF300-C3	CTLM-3H3SF300-C3
Optical resolution	60:1	100:1	300:1		
Temperature range <sup>1,2</sup>	50 to 400°C	100 to 600°C	150 to 1000°C	200 to 1500°C	250 to 1800°C
Spectral range	2.3μm				
System accuracy <sup>3</sup>	±(0.3% of reading +2°C)				
Repeatability <sup>3</sup>	±(0.1% of reading +1°C)				
Temperature resolution (digital)	0.1°C				
Response time (90% signal) <sup>4</sup>	1ms				
Emissivity/gain <sup>1</sup>	0.100 to 1.100				
Transmissivity/gain <sup>1</sup>	0.100 to 1.100				
Signal processing <sup>1</sup>	peak hold, valley hold, average; extended hold function with threshold and hysteresis				
Certificate of calibration	optional				
Outputs/analogue	channel 1	0/4 to 20mA, 0 to 5/ 10V, thermocouple J, K			
Outputs/analogue (option)		relay: 2 x 60VDC / 42VAC; 0.4A; optically isolated			
Alarm output		open-collector (24V / 50mA)			
Outputs/digital	option	USB, RS232, RS485, CAN, Profibus DP, Ethernet			
Output impedances	current output	mA max. 500Ω (with 5 - 36VDC)			
	voltage output	mV min. 100kΩ load impedance; thermocouple 20Ω			
Inputs		programmable functional inputs for external emissivity adjustment, ambient temperature compensation, trigger (reset of hold functions)			
Cable length		3m (standard), 8m, 15m			
Power supply		8 to 36 VDC; max. 160mA			
Laser		class II (635nm), 1mW, ON/OFF via controller or software			
Environmental rating		IP 65 (NEMA-4)			
Ambient temperature		sensor: -20°C to 85°C (50°C if laser ON) controller: 0°C to 85°C			
Storage temperature		sensor: -40°C to 85°C controller: -40°C to 85°C			
Relative humidity		10 to 95%, non condensing			
Vibration	sensor	IEC 68-2-6: 3G, 11-200Hz, any axis			
Shock	sensor	IEC 68-2-27: 50G, 11ms, any axis			
Weight		sensor: 600g; controller: 420g			

<sup>1</sup> adjustable via controller or software

<sup>2</sup> target temperature > sensor temperature + 25°C

<sup>3</sup> E=1, response time 1s; ± ambient temperature: 23 ±5°C

<sup>4</sup> with dynamic adaptation at low signal levels

### Optical specifications thermoMETER CTLaserM3

□ = smallest spot size (mm)

Close Fokus															
<b>3LCF4</b>	<b>60:1</b>	20	18.7	17.3	15.9	14.5	13.1	11.7	10.3	9	7.5	10.6	17	23	29
<b>3HCF4</b>	<b>100:1</b>	20	18.3	16.6	14.9	13.2	11.4	9.7	8	6.3	4.5	7.3	13	19	24
<b>3 H1/H2/H3 CF4</b>	<b>300:1</b>	20	18	16	13.8	11.8	9.7	7.6	5.6	3.5	1.4	3.8	8.6	13.3	18
distance (mm)		0	50	100	150	200	250	300	350	400	450	500	600	700	800
Far Field															
<b>3 H1/H2/H3 FF</b>	<b>300:1</b>	20	19	18	17	16	15	14	13.4	12	16.5	24.4	33.4	40	
distance (mm)		0	450	900	1350	1800	2250	2700	3000	3600	4000	5000	6000	6750	

### Accessories page 22 - 23

- ▶ Mounting bracket
- ▶ Air purge collar
- ▶ Rail mount adapter for controller
- ▶ Water cooled housing
- ▶ Interface kit
- ▶ Software CompactConnect
- ▶ Certificate of calibration

**Controller**

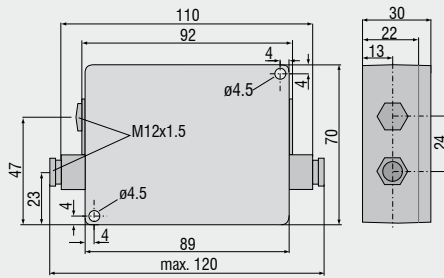

**CTLaser / CTLaserFAST / CTLaserGLASS / CTLaserM1/M2 / CTLaserM3 / CTLaserM5 / CTLaserCOMBUSTION**

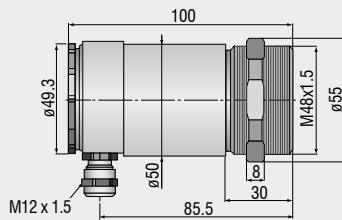

**CTratioM1**

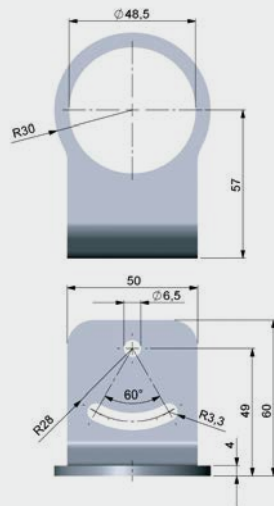
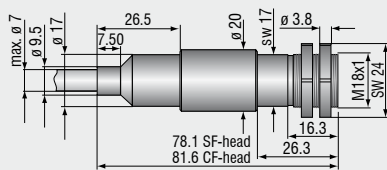

TM-FB-CTL Mounting bracket (fixed); included with CTL sensors

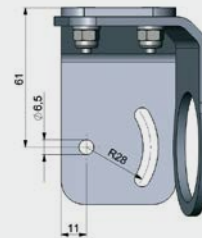
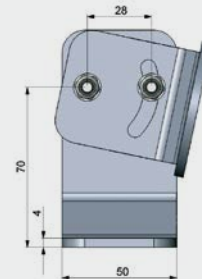

TM-AB-CTL Mounting bracket (adjustable)



TM-W-CTL Water cooled housing and air purge collar TM-AP-CTL, mounted on adjustable mounting bracket TM-AB-CTL

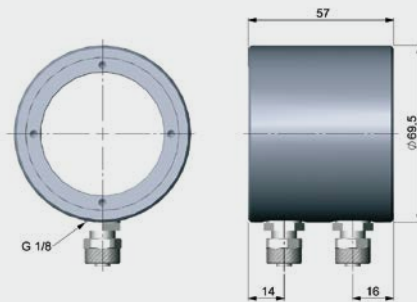

TM-W-CTL Water cooled housing

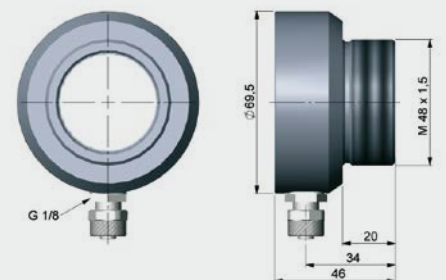

TM-AP-CTL Air purge collar



**Mechanical accessories**

Art. No.	Model	
2970238	TM-AB-CTL	Mounting bracket, adjustable, stainless steel
2970239	TM-AP-CTL	Air purge collar, stainless steel
2970240	TM-W-CTL	Water cooled housing, stainless steel, for ambient temperatures up to 175°C
2970241	TM-RAIL-CTL	Rail mount adapter for CTlaser controller
2970242	TM-COV-CTL	Closed cover for controller
2970243	TM-MN-CTL	Mounting nut, stainless steel (spare)
2970244	TM-FB-CTL	Mounting bracket, fixed, stainless steel (spare)
2970298	TM-A20UN-CTL	Screw adapter M48x1 on 20UN-2A screw including mounting nut

**High temperature accessories**

2970366	TM-J-CTL	Cooling jacket (length 228mm, ø89mm) (connection kit TM-CONK-CTL is required)
2970374	TM-CONK-CTL	Connection kit: sensor with axial cable exit, for integration in cooling jacket
2970368	TM-JAB-CTL	Adjustable mounting bracket for cooling jacket
2970369	TM-MF-CTL	Mounting flange M48x1.5 for TM-PF-CTL
2970370	TM-AST300-CTL	Sighting tube M48x1.5, 300 mm length
2970371	TM-PA-CTL	Pipe adapter M48x1.5
2970372	TM-RM-CTL	Furnace wall mount accessory for CTlaser (TM-MF-CTL, TM-AST300-CTL and TM-PA-CTL)
2970412	TM-PF-CTL	Pipe flange M48x1.5 for direct mounting a CTL sensor

**Calibration**

2970253	TM-CERT-CTL	Certificate of calibration
2970324	TM-HTCERT-CTL	Certificate of calibration for CTlaser M1-/M2-/M3-/M5-/G-sensors

**Interfaces**

2970245	TM-USBK-CTL	USB interface kit incl. computer cable, software CompactConnect
2970246	TM-RS232K-CTL	RS232 interface kit incl. computer cable, software CompactConnect
2970338	TM-RS485USBK-CTL	RS485-USB-adapter, incl. PC cable, RS485 board, software CTconnect, terminal block, for use with TM-485B-CTL
2970248	TM-RS485B-CTL	RS485 interface board
2970249	TM-CANK-CTL	CAN-Bus interface for optris CT/ protocol: CANopen Presettings: module address 20 (14H), 250kbaud, 0-60°C
2970250	TM-PFBDPK-CTL	Profibus-DPV1 interface for CT selectable with DIN M12 or SUB-D connection
2970251	TM-ETHNK-CTL	Ethernet-Kit: interface board, external Ethernet adapter, software CompactConnect
2970252	TM-RI-CTL	Relay interface: Two optically isolated relays, 60VDC/ 42VAC <sub>RMS</sub> , 0.4A

**Sensor cables and high temperature cables**

2970374	TM-CONK-CTL	Connector-Kit for cables with connector
4800254.003	TM-CB3C-CTL	Sensor cable with adapter (3m)
4800254.003H	TM-CB3HC-CTL	High-temperature sensor cable with adapter (3m)
4800254.008	TM-CB8C-CTL	Sensor cable with adapter (8m)
4800254.008H	TM-CB8HC-CTL	High-temperature sensor cable with adapter (8m)
4800254.015	TM-CB15C-CTL	Sensor cable with adapter (15m)
4800254.015H	TM-CB15HC-CTL	High-temperature sensor cable with adapter (15m)



TM-J-CTL Cooling jacket (length 228mm, ø89mm) with adjustable mounting bracket TM-JAB-CTL; up to 315°C ambient temperature



TM-PF-CTL and TM-MF-CTL Mounting flange M48x1.5 for direct mounting a CTL sensor



TM-RM-CTL Furnace wall mount accessory for CTlaser / resp. CTratio: TM-MF-CTL, TM-PF-CTL, TM-AST300-CTL and TM-PA-CTL

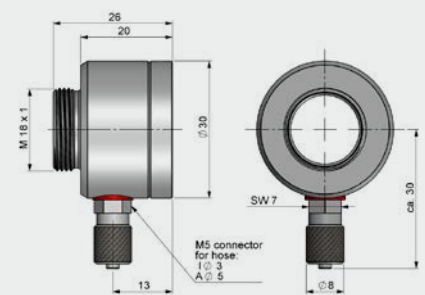

TM-AP-CTR Air purge collar

**CTratio**

Art. No.	Model	
2970348	TM-FB-CTR	Mounting bracket, adjustable in one axis
2970395	TM-AP-CTR	Air purge collar
2970373	TM-RM-CTR	Furnace wall mount accessory for CTratio
2970351	TM-CERT-CTR	Certificat of calibration

## High performance sensors made by Micro-Epsilon



Sensors and systems for displacement and position



Sensors and measurement devices for non-contact temperature measurement



2D/3D profile sensors (laser scanner)

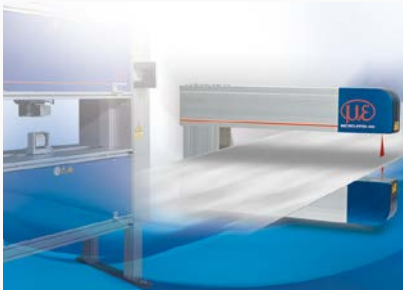

Measurement and inspection systems for quality assurance



Optical micrometers, fibre optic sensors and optical fibres



Colour recognition sensors, LED analysers and colour online spectrometer



MICRO-EPSILON Headquarters  
Koenigbacher Str. 15 · 94496 Ortenburg / Germany  
Tel. +49 (0) 8542 / 168-0 · Fax +49 (0) 8542 / 168-90  
info@micro-epsilon.com · www.micro-epsilon.com

MICRO-EPSILON UK Ltd.  
No.1 Shorelines Building · Shore Road · Birkenhead · CH41 1AU  
Phone +44 (0) 151 355 6070 · Fax +44 (0) 151 355 6075  
info@micro-epsilon.co.uk · www.micro-epsilon.co.uk