



# More Precision

**thermoMETER**  
Non-contact IR temperature sensors





### thermoMETER CTlaser

*Innovative precision infrared temperature sensor marking the actual spot size on your measurement target at any distance*

- Measuring range from  $-50^{\circ}\text{C}$  to  $975^{\circ}\text{C}$
- Extreme small measurement spot down to 0.9mm
- Real mapping of the actual spot size, with automatic laser protection
- Precision optics (75:1) with different models for a specific focus point
- Up to  $85^{\circ}\text{C}$  ambient temperature without cooling
- Fully programmable instrument for enhanced signal processing and I/O control
- Separate controller with easy accessible programming keys and multi colour LCD backlit display

### Optical specifications thermoMETER CTlaser

□ = smallest spot size (mm)

Standard optics																	
<b>SF75 optics</b>	<b>75:1</b>	20	19.5	19	18.5	18	17.5	17	16.5	16	20.5	25	34	43	52		
distance in mm		0	150	300	450	600	750	900	1050	1200	1350	1500	1800	2100	2400		
Close Focus optics																	
<b>CF1 optics</b>	<b>75:1</b>	20	9	5	0.9	10	25	40	55	70	85	100	115	130	160	190	220
<b>CF2 optics</b>	<b>75:1</b>	20	16	14	11	8	1.9	9	16.5	24	31	38	45.5	53	68	82	97
<b>CF3 optics</b>	<b>75:1</b>	20	17	16	14	11	7	2.75	8.5	14	19.5	25.5	31	37	48	60	71
<b>CF4 optics</b>	<b>75:1</b>	20	19	18.5	18	17	15.5	14	12.5	11	9	7.5	5.9	9	15	20	26
distance in mm		0	40	50	70	100	150	200	250	300	350	400	450	500	600	700	800

## Product identification

CTL - SF75 - C3

Cable length [3 m Standard / 8 m / 15 m]  
 Focus [SF75 / CF1 / CF2 / CF3 / CF4]  
 thermoMETER CTLaser

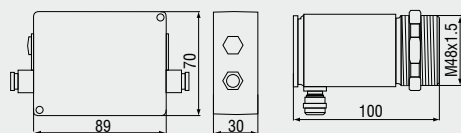

Model	CTL-SF75-C3	
Optical resolution	75:1	
Temperature range <sup>1</sup>	-50°C to 975°C	
Spectral range	8 to 14µm	
System accuracy <sup>2,3</sup>	±1% or ±1°C	
Repeatability <sup>2</sup>	±0.5% or ±0.5°C	
Temperature resolution	0.1°C	
Response time (90% signal)	120ms	
Emissivity/gain <sup>1</sup>	0.100 to 1.100	
Transmissivity/gain <sup>1</sup>	0.100 to 1.000	
Signal processing <sup>1</sup>	peak hold, valley hold, average; extended hold function with threshold and hysteresis	
Certificate of calibration	optional	
Outputs/analogue	channel 1 channel 2 optional	0/4 to 20mA, 0 to 5/10V, thermocouple J, K sensor temperature (-20 to 180°C as 0 to 5V or 0 to 10V), alarm output relay: 2 x 60VDC/ 42VAC <sub>eff</sub> ; 0.4A; optically isolated
Alarm output		open - collector (24V/ 50mA)
Outputs/digital	optional	USB, RS232, RS485, CAN, Profibus DP, Ethernet
Output impedances	current output voltage output	mA max. 500Ω (with 5 to 36VDC) mV min. 100kΩ load impedance; thermocouple 20Ω
Inputs		programmable functional inputs for external emissivity adjustment, ambient temperature compensation, trigger (reset of hold functions)
Cable length		3m (standard), 8m, 15m
Power supply		8 to 36VDC; max. 160mA
Laser		class II (635nm), 1mW, ON/OFF via controller or software
Environmental rating		IP 65 (NEMA-4)
Ambient temperature		sensor: -20°C to 85°C (50°C if Laser ON) controller: 0°C to 85°C
Storage temperature		sensor: -40°C to 85°C controller: -40°C to 85°C
Relative humidity		10 to 95%, non condensing
Vibration	sensor	IEC 68-2-6: 3 G, 11 to 200Hz, any axis
Shock	sensor	IEC 68-2-27: 50 G, 11ms, any axis
Weight		sensor: 600g; controller: 420g

<sup>1</sup> adjustable via controller or software

<sup>2</sup> ± ambient temperature: 23 ±5°C; whichever is greater

<sup>3</sup> temperature of the object >0°C

## Accessories page 22 - 23

- ▶ Mounting bracket
- ▶ Air purge collar
- ▶ Rail mount adapter for controller
- ▶ Water cooled housing
- ▶ Interface kit
- ▶ Software CompactConnect
- ▶ Certificate of calibration



**LASER RADIATION**  
 DO NOT STARE IN THE BEAM  
 CLASS 2 LASER  
 EN60825-1:2002  
 P≤1mW; λ=630-650nm

**Controller**

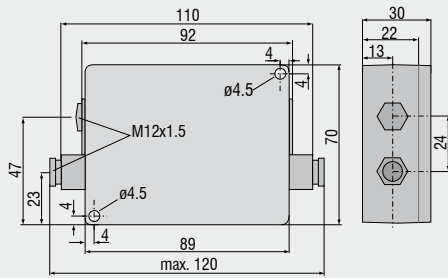

**CTLaser / CTLaserFAST / CTLaserGLASS / CTLaserM1/M2 / CTLaserM3 / CTLaserM5 / CTLaserCOMBUSTION**

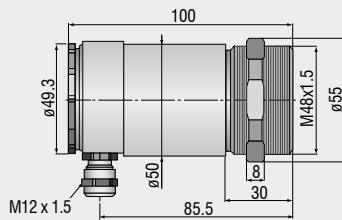

**CTratioM1**

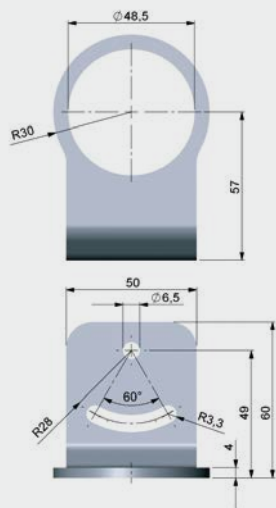
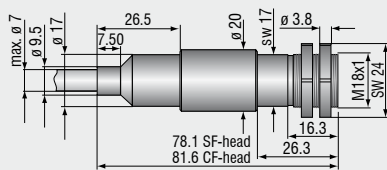

TM-FB-CTL Mounting bracket (fixed); included with CTL sensors

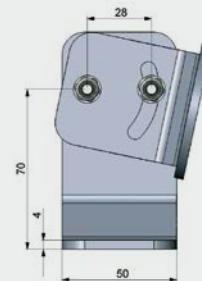

TM-AB-CTL Mounting bracket (adjustable)

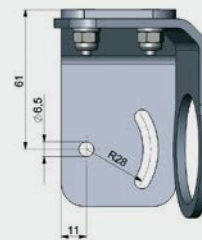

TM-W-CTL Water cooled housing and air purge collar TM-AP-CTL, mounted on adjustable mounting bracket TM-AB-CTL

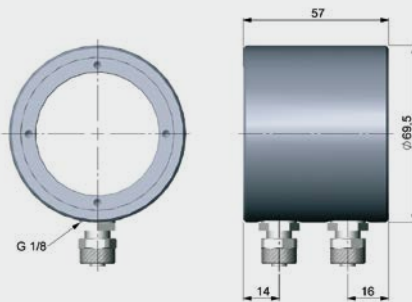

TM-W-CTL Water cooled housing

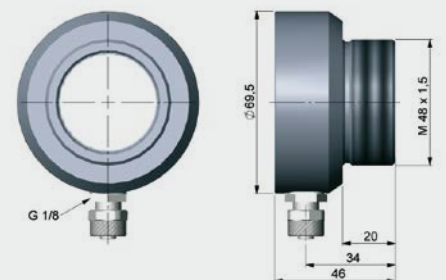

TM-AP-CTL Air purge collar

**Mechanical accessories**

Art. No.	Model	
2970238	TM-AB-CTL	Mounting bracket, adjustable, stainless steel
2970239	TM-AP-CTL	Air purge collar, stainless steel
2970240	TM-W-CTL	Water cooled housing, stainless steel, for ambient temperatures up to 175°C
2970241	TM-RAIL-CTL	Rail mount adapter for CTlaser controller
2970242	TM-COV-CTL	Closed cover for controller
2970243	TM-MN-CTL	Mounting nut, stainless steel (spare)
2970244	TM-FB-CTL	Mounting bracket, fixed, stainless steel (spare)
2970298	TM-A20UN-CTL	Screw adapter M48x1 on 20UN-2A screw including mounting nut

**High temperature accessories**

2970366	TM-J-CTL	Cooling jacket (length 228mm, ø89mm) (connection kit TM-CONK-CTL is required)
2970374	TM-CONK-CTL	Connection kit: sensor with axial cable exit, for integration in cooling jacket
2970368	TM-JAB-CTL	Adjustable mounting bracket for cooling jacket
2970369	TM-MF-CTL	Mounting flange M48x1.5 for TM-PF-CTL
2970370	TM-AST300-CTL	Sighting tube M48x1.5, 300 mm length
2970371	TM-PA-CTL	Pipe adapter M48x1.5
2970372	TM-RM-CTL	Furnace wall mount accessory for CTlaser (TM-MF-CTL, TM-AST300-CTL and TM-PA-CTL)
2970412	TM-PF-CTL	Pipe flange M48x1.5 for direct mounting a CTL sensor

**Calibration**

2970253	TM-CERT-CTL	Certificate of calibration
2970324	TM-HTCERT-CTL	Certificate of calibration for CTlaser M1-/M2-/M3-/M5-/G-sensors

**Interfaces**

2970245	TM-USBK-CTL	USB interface kit incl. computer cable, software CompactConnect
2970246	TM-RS232K-CTL	RS232 interface kit incl. computer cable, software CompactConnect
2970338	TM-RS485USBK-CTL	RS485-USB-adapter, incl. PC cable, RS485 board, software CTconnect, terminal block, for use with TM-485B-CTL
2970248	TM-RS485B-CTL	RS485 interface board
2970249	TM-CANK-CTL	CAN-Bus interface for optris CT/ protocol: CANopen Presettings: module address 20 (14H), 250kbaud, 0-60°C
2970250	TM-PFBDPK-CTL	Profibus-DPV1 interface for CT selectable with DIN M12 or SUB-D connection
2970251	TM-ETHNK-CTL	Ethernet-Kit: interface board, external Ethernet adapter, software CompactConnect
2970252	TM-RI-CTL	Relay interface: Two optically isolated relays, 60VDC/ 42VAC <sub>RMS</sub> , 0.4A

**Sensor cables and high temperature cables**

2970374	TM-CONK-CTL	Connector-Kit for cables with connector
4800254.003	TM-CB3C-CTL	Sensor cable with adapter (3m)
4800254.003H	TM-CB3HC-CTL	High-temperature sensor cable with adapter (3m)
4800254.008	TM-CB8C-CTL	Sensor cable with adapter (8m)
4800254.008H	TM-CB8HC-CTL	High-temperature sensor cable with adapter (8m)
4800254.015	TM-CB15C-CTL	Sensor cable with adapter (15m)
4800254.015H	TM-CB15HC-CTL	High-temperature sensor cable with adapter (15m)



TM-J-CTL Cooling jacket (length 228mm, ø89mm) with adjustable mounting bracket TM-JAB-CTL; up to 315°C ambient temperature

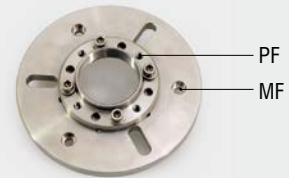

TM-PF-CTL and TM-MF-CTL Mounting flange M48x1.5 for direct mounting a CTL sensor



TM-RM-CTL Furnace wall mount accessory for CTlaser / resp. CTratio: TM-MF-CTL, TM-PF-CTL, TM-AST300-CTL and TM-PA-CTL

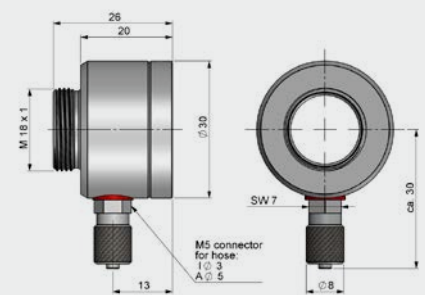

TM-AP-CTR Air purge collar

**CTratio**

Art. No.	Model	
2970348	TM-FB-CTR	Mounting bracket, adjustable in one axis
2970395	TM-AP-CTR	Air purge collar
2970373	TM-RM-CTR	Furnace wall mount accessory for CTratio
2970351	TM-CERT-CTR	Certificat of calibration

## High performance sensors made by Micro-Epsilon



Sensors and systems for displacement and position



Sensors and measurement devices for non-contact temperature measurement



2D/3D profile sensors (laser scanner)

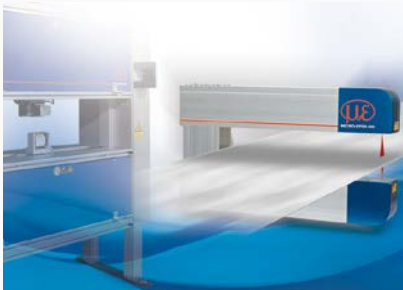

Measurement and inspection systems for quality assurance



Optical micrometers, fibre optic sensors and optical fibres



Colour recognition sensors, LED analysers and colour online spectrometer



MICRO-EPSILON Headquarters  
Koenigbacher Str. 15 · 94496 Ortenburg / Germany  
Tel. +49 (0) 8542 / 168-0 · Fax +49 (0) 8542 / 168-90  
info@micro-epsilon.com · www.micro-epsilon.com

MICRO-EPSILON UK Ltd.  
No.1 Shorelines Building · Shore Road · Birkenhead · CH41 1AU  
Phone +44 (0) 151 355 6070 · Fax +44 (0) 151 355 6075  
info@micro-epsilon.co.uk · www.micro-epsilon.co.uk